

Aritco 4000 = our most compact home lift



Aritco 4000

The lift has been designed to meet all requirements for comfort, space and design. The lift is available in different sizes, with an option to personalise it with details such as glass walls, a range of varied colours and different materials.

Several advantages offered by Aritco 4000:

- Design, sizes and options created for a home environment
- Minimum interventions in the house
- 95% recyclable materials
- 'A' rated energy consumption according to VDI4707
- Patented screw/nut technology (no oil that can leak)
- The lowest maintenance and operating costs on the market

For more information please visit:
aritcohomelifts.com/4000



ARITCO (THAILAND) CO., LTD.
467/2 Rama 3 Charoenrat Rd., Bang Khlo
Bang Kho Laem, Bangkok 10120, Thailand
Tel: 02 - 408 - 0200
Fax: 02 - 638 - 8877
Email: Sales@aritco.co.th

Website: www.aritco.co.th • [Facebook.com/aritco.co.th](https://www.facebook.com/aritco.co.th)



Aritco 4000

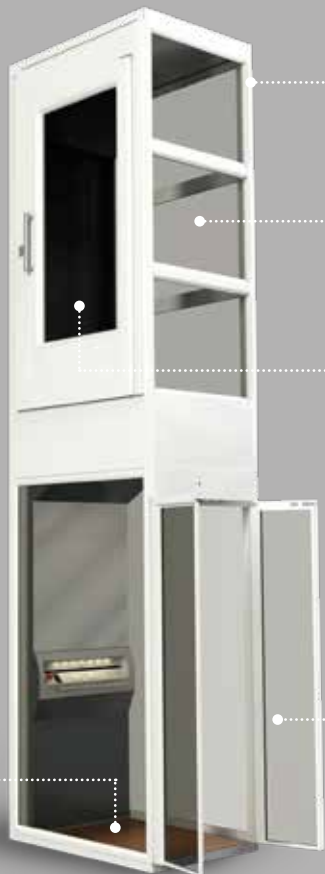

LIFT COLOUR

Can be painted in any RAL colour from the RAL Classic chart.

GLASS

4 different glass types to choose from.



DOORS

2 different door types to choose from.

FLOOR

9 different floorings to choose from.

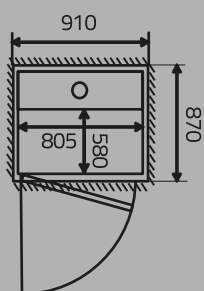

Size: 580 x 805 mm

Rated load: 250 kg / 2 persons

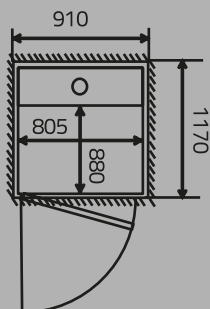

Size: 880 x 805 mm



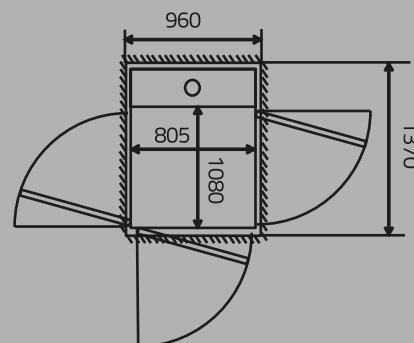



Rated load: 250 kg / 2 persons



Size: 1080 x 805 mm

Rated load: 250 kg / 2 persons

Product summary

| | | | | | |
|--|--|---|--|---|--|
| <p>TOP HEIGHT</p> <p>2300 mm</p> | <p>TYPE OF LIFT Home lift intended for installation in private homes.</p> | <p></p> <p>RATED SPEED</p> <p>Max 0,15 m/s</p> | <p></p> <p>DRIVE SYSTEM</p> <p>Patented screw and nut system</p> <p>1.5 kW motor</p> | <p>CONTROL FROM CARRIER CONTROL PANEL</p> <p>Hold to run - press and hold</p> <p>For installations outside Europe</p> <p>One touch operation (press one time)</p> | <p>NUMBER OF FLOORS</p> <p></p> <p>2 to 6 floors</p> |
| <p></p> <p>INSTALLATION</p> <p>Recessed installation 50 mm below floor Installed directly on floor with 50 mm ramp</p> | <p>INDOOR INSTALLATION ENVIRONMENT</p> | <p>TRAVEL HEIGHT</p> <p>250-13000 millimeter</p> | <p></p> <p>WARRANTY</p> <p>Aritco 4000 comes with a 24 months warranty. The screw and nut assembly has a 10 year warranty.</p> | <p></p> <p>TECHNICAL COMPLIANCE</p> <p>European Machine directive 2006/42/EC European standard EN 81-41</p> | |
| <p>Control voltage 24 V</p> <p><i>Emergency lowering : Battery-powered</i></p> | | | | | |